

TECHNICAL DATA SHEET

ALU 090-115

Non combustible pedestal ALU 90-115 mm (3 6/11" - 4 1/2")

BASIC INFORMATION

Product name	Non combustible pedestal ALU 90-115 mm (3 6/11" - 4 1/2")
Trade name	ALU 090-115
Product group	Adjustable pedestals - ALU series
Application	Terrace with tiles
Code	10995

FEATURES

- Smooth height adjustment from 90 to 115 mm (from 3 6/11" to 4 1/2").
- Aluminum, fire-resistant safety pedestals, EURO A1 class.
- Built-in self-leveling function from 0 to 6%.
- High load capacity.
- Adapted to tiles/pavers.

DESCRIPTION

The ALU series has been specially designed for professional terraces that are built in facilities where higher fire resistance is required. It is used in projects with increased requirements. The durable aluminum construction provides high load capacity, allowing for the maintenance of large loads. The ALU series pedestals have a smooth adjustment function, which allows for achieving any height in the range of 40 to 200 mm (1 4/7" to 8"). Additionally, they have a built-in self-leveling function, allowing for achieving a horizontal terrace surface without the need for additional accessories on a slope of up to 6%. They are also resistant to loads and mechanical damage, making them ideal for professional applications.



PARAMETERS

Minimum height	90 mm (3 6/11")
Maximum height	115 mm (4 1/2")
Height adjustment type	Smooth height adjustment
Cap diameter	Ø 100 mm (78,5 cm ²) Ø 4" (12,17 in ²)
Base diameter	Ø 130 mm (132,7 cm ²) Ø 1 1/3" (20,57 in ²)
Tile gap width	3 mm (1/8")
Weight	0,402 kg 0.886 lbs
Load resistance	up to 2000 kg up to 4400 lbs
Operating temperature	-20°C; +65°C -4°F; +149°F
Color	Aluminum
Material	Aluminum

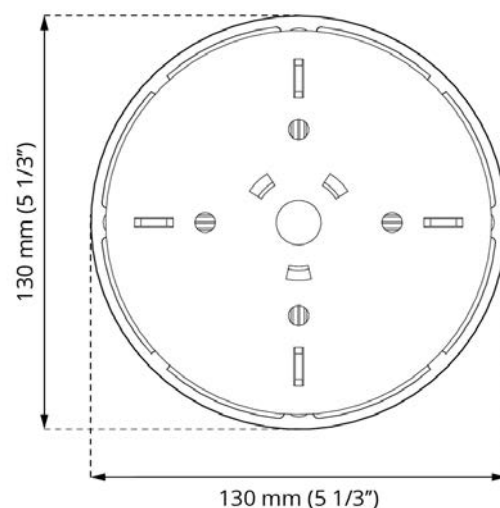
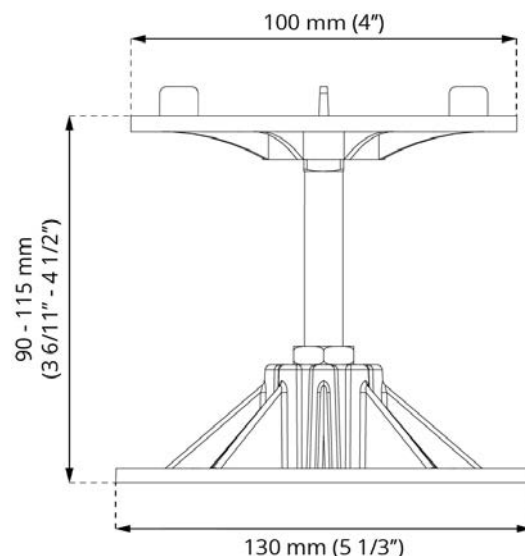

APPLICATION

- Terrace with tiles with improved fire resistance.

COMPONENTS

- The ALU 090-115 pedestal is composed of:
Base + Base screw nut + Low height locking nut + Screw + Head

FIRE RESISTANCE

- The structure of the pedestals is made entirely of fireproof materials, safety class EURO A1.
- The pedestals have no plastic or rubber elements.



PEDESTAL HEAD

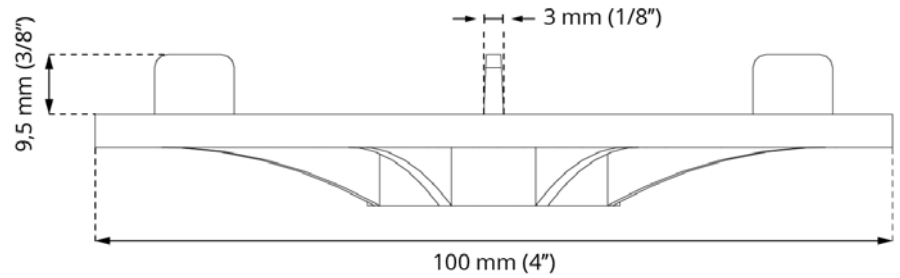
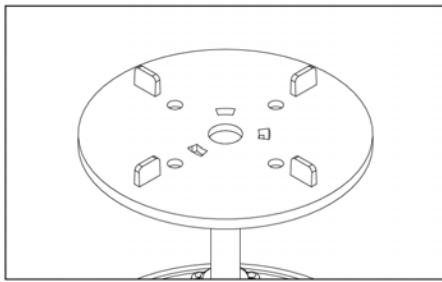

SELF LEVELLING

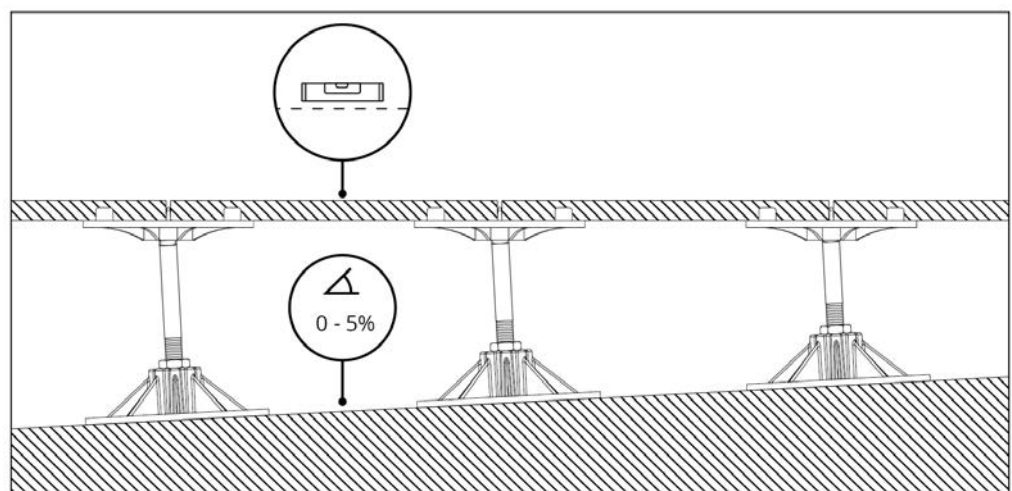
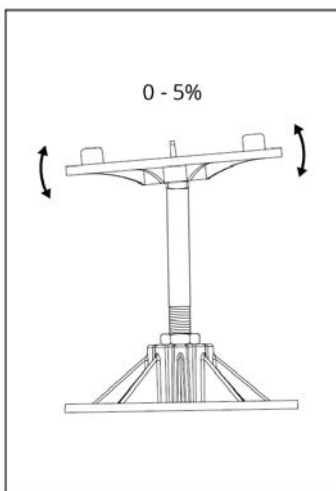

USAGE

ALU pedestals are designed for use with tiles/pavers. Made of five aluminum elements: base, high nut, low nut, screw, and cap. They have built-in 3 mm (1/8") gap spacers on the cap and the ability for smooth adjustment using a screw, which is locked in place by two nuts - in the base and counter. The screw also allows for self-leveling of the pedestal cap.

DATA LOGISTICS

Product	Type	Size	Quantity	Weight brutto
ALU 090-115	Carton box	30 x 50 x 20 cm (11 4/5" x 19 2/3" x 7 7/8")	30 pcs.	12,51 kg (27.58 lbs)
	Pallet	120 x 100 x 220 cm (47 1/4" x 39 1/2" x 86")	2400 pcs.	1021 kg (2 250.92 lbs)

EXAMPLE OF SERIES ALU APPLICATION

