

# PLOTS DE TERRASSE

POUR DALLES ET TERRASSES EN BOIS OU EN COMPOSITE



## SÉRIE SPIRALE

POUR DALLES ET  
LAMBOURDES



## SÉRIE PLAQUES

POUR DALLES



SÉRIE **STANDARD**

POUR DALLES ET  
LAMBOURDES



SÉRIE **MAX**

POUR DALLES ET  
LAMBOURDES



# SÉRIE PLAQUES

## 2 / 8 / 10 / 15 / 16 MM

Plaques fixes pour dalles de terrasse



2 MM



8 MM



10 MM



15 MM

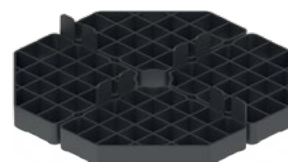

16 MM

002

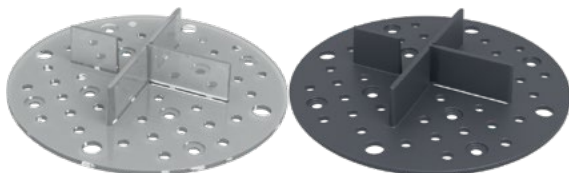

**INVISIBLES DANS LA FENTE**  
Matériau transparent, noir, en caoutchouc

008



**EN CAOUTCHOUC**  
Garantit un confort d'utilisation  
Empilables

010  
015



**MODULAIRES ET EMPILABLES**  
Possibilité d'empiler les plaques

016



**SOLIDES ET EMPILABLES**  
Solidité incroyable au-dessus de 2000 kg\*



**POUR  
DALLES**

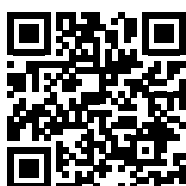

# SÉRIE SPIRALE

## 10-210 MM

Le nivellement à partir des hauteurs les plus basses

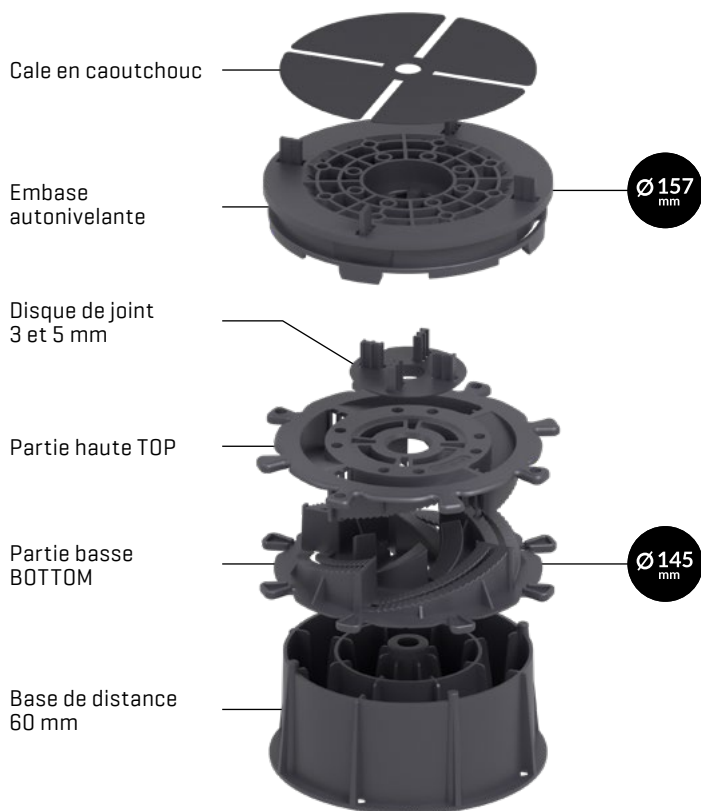

 **EMBASE AUTONIVELANTE**  
Corrige automatiquement une pente de 0 à 6 %

 **BASSES HAUTEURS**  
Gamme de réglage à partir de 10 mm

 **SOLIDITÉ**  
Résistance aux charges jusqu'à 1900 kg\*

 **RÉGLAGE DE LA HAUTEUR**  
Réglage de la hauteur tous les 1 mm

 **FACILE À UTILISER**  
Très facile et rapide à utiliser

 **POUR DALLES**

 **POUR LAMBOURDES**

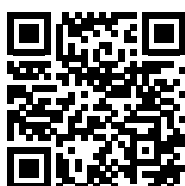

# SÉRIE STANDARD

## 30-420 MM

Solution universelle et solide

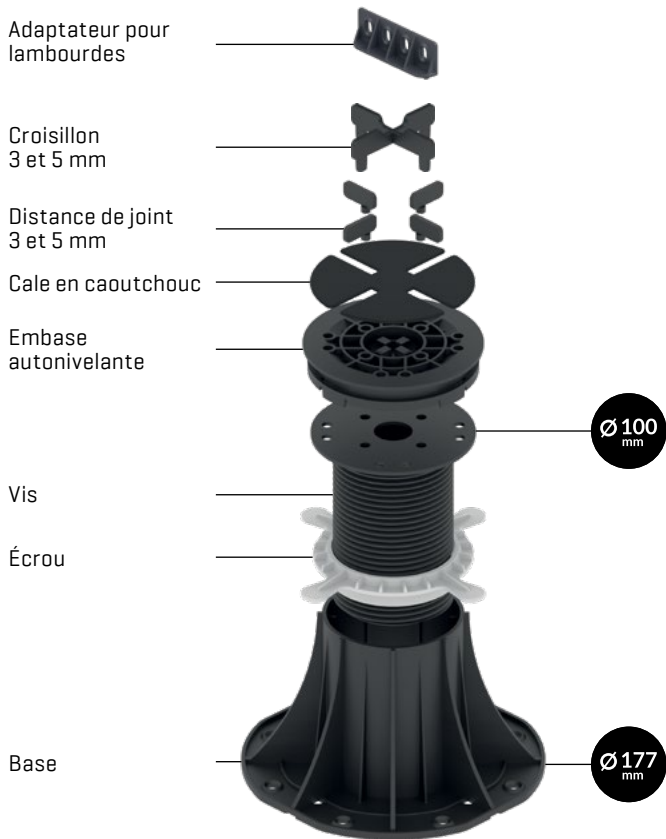

- EMBASE AUTONIVELANTE**  
 Corrige automatiquement une pente de 0 à 7 %
- GAMME UNIVERSELLE DE HAUTEURS**  
 Gamme de réglage de la hauteur de 30 à 420 mm
- CHARGE ÉLEVÉE**  
 Résistance aux charges même jusqu'à 1000 kg\*
- RÉGLAGE DE LA HAUTEUR DANS L'ÉCROU**  
 Réglez facilement la hauteur
- POLYVALENCE**  
 Large gamme d'accessoires



POUR  
DALLES



POUR  
LAMBOURDES

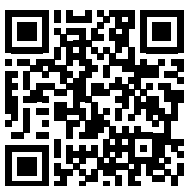

# SÉRIE MAX

## 45-950 MM

Conceptions avancées,  
capacité maximale



45-75 MM



75-150 MM



150-350 MM



350-550 MM  
550-750 MM  
750-950 MM

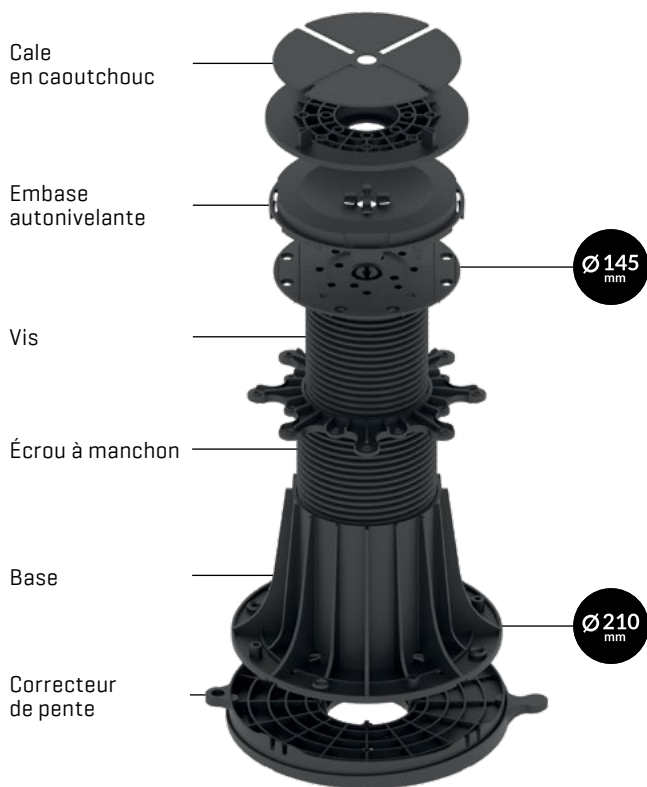

### RÉGLAGE DE LA HAUTEUR

8% Correcteur de pente  
6% Embase autonivelante



### LARGE GAMME DE HAUTEURS

3 plots avec une large gamme de réglage de la hauteur



### USAGE PROFESSIONNEL

Résistance aux charges même jusqu'à 1700 kg\*



### PROTECTION CONTRE LE VENT

Solution système pour la protection contre les vents forts



### CONSTRUCTION STABLE

Possibilité de stabilisation supplémentaire de la construction



POUR  
DALLES



POUR  
LAMBOURDES



\* Les valeurs détaillées pour les hauteurs individuelles sont indiquées dans la spécification technique.



**DD GROUP**  
INNOVATIVE PRODUCTS

[www.ddpedestals.eu](http://www.ddpedestals.eu)  
[sales@ddpedestals.eu](mailto:sales@ddpedestals.eu)

**DECK-DRY Polska Sp. z o. o.**  
80-299 Gdańsk, ul. Wenus 73A, Pologne  
tél. [+48] 58 511 04 31  
tél. port. [+48] 517 062 150

100%  
FABRIQUÉ EN POLOGNE

