



ADJUSTABLE PEDESTALS







SPIRAL SERIES





- Self leveling head automatically adjust to slope (0-6%).
- Load resistance up to 2400 kg on each center loaded pedestal.
- Minimum height starts from 10 mm (6/16").
- Step height adjustment, each step is 1 mm (1/32").
- Select 3 mm or 5 mm (1/8 or 3/16") tab size for pavers.
- Select joist adapter for decking.
- Additional accessories as: Rubber shim, Up to wall perimeter clip, Vertical closure clip, Rubber SBR pads.
- Made in EU.

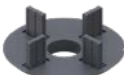

Copyright 2022 DD GROUP. All rights reserved.

SPIRAL SERIES

	Model No.	Description	Range	Notes
Pedestals	 SPIRAL 010-017	Adjustable Pedestal	10 - 17 mm (6/16" - 11/16")	Step height adjustment 1 mm (1/32").
	 SPIRAL 017-030	Adjustable Pedestal	17 - 30 mm (11/16" - 1 3/16")	Step height adjustment 1 mm (1/32").
	 SPIRAL 030-050	Adjustable Pedestal	30 - 50 mm (1 3/16" - 1 15/16")	Step height adjustment 1 mm (1/32").
	 SPIRAL 050-070	Adjustable Pedestal	50 - 70 mm (1 15/16" - 2 3/4")	Step height adjustment 1 mm (1/32").
	 SPIRAL 070-090	Adjustable Pedestal	70 - 90 mm (2 3/4" - 3 1/2")	Step height adjustment 1 mm (1/32").
	 DS60	Height coupler	60 mm (2 1/3")	Height coupler allows to extend pedestal height with additional 60 mm (2 1/3") (up to 210 mm (8 1/3")).
Tabs	 D3 D5	Gap spacer disc	-	Select 3 mm (1/8") or 5 mm (3/16") paver gap spacer.
	 L3 L5	Gap spacer	-	Select 3 mm (1/8") or 5 mm (3/16") paver gap spacer.
	 AD	Joist adapter	-	For decking joist fixing with pedestals.

		SH145	Rubber shim SH145	Adds 1,5 mm (1/16") in height	Noise cancellation and tile thickness compensation.
		LE MAX	Self leveling head LE MAX 0-6%	Adds 20 mm (3/4") in height	Self leveling of the terrace with a slope range from 0% to 6%.
Accessories		DDPWAP	Up to wall clip	Adds 2,5 mm (1/11") in height	Use to create a gap between perimeter tile and wall. Prevent tiles displacement and makes a spare space for tiles thermal expansion.
		DDP CP	Side finishing closure plate	Adds 3,5 mm (1/8") in height	It is used to make vertical masking of the ventilated terrace. Two pieces increase the height of the bracket by 7 mm (3/11").
		SBR 200/3 SBR 200/8	SBR rubber pad	Adds 3 or 8 mm (1/8" or 5/16") in height	Select 3 mm (1/8") or 8 mm (5/16") height option. Placed under the pedestal gives additional protection of the water membrane. Also gives additional noise cancellation.

Copyright 2022 DD GROUP. All rights reserved.

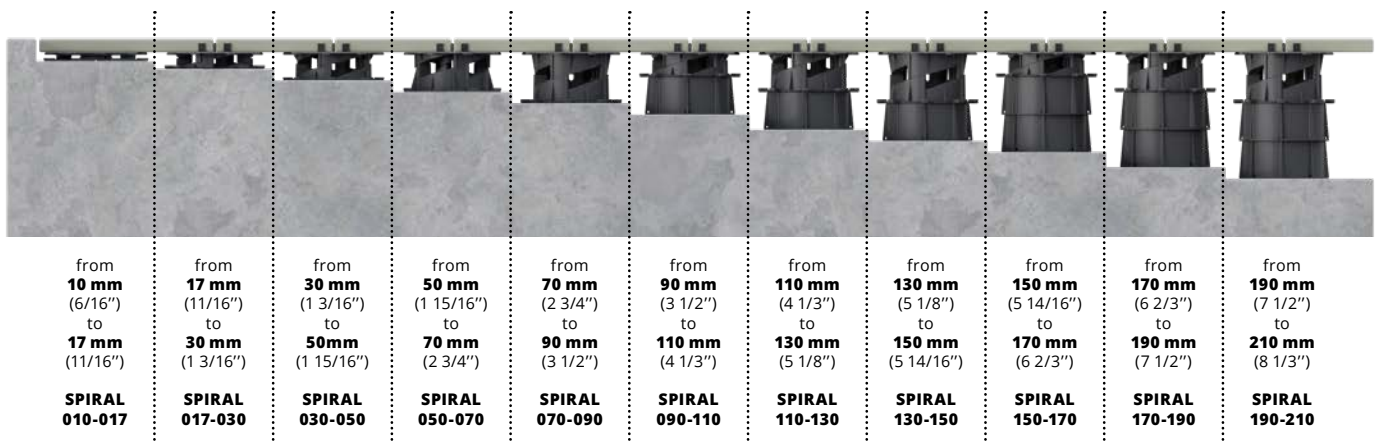

IMPORTANT: Refer to DD PEDESTALS product specifications to ensure proper use and installation. Find specifications at www.ddgro.eu