



ADJUSTABLE PEDESTALS









SPIRAL SERIES

- Self leveling head automatically adjust to slope (0-6%).
- Load resistance up to 2400 kg on each center loaded pedestal.
- Minimum height starts from 10 mm.
- Step height adjustment, each step is 1 mm.
- Select 3 mm or 5 mm tab size for pavers.
- Select joist adapter for decking.
- Additional accessories as: Rubber shim, Up to wall perimeter clip, Vertical closure clip, Rubber SBR pads.
- Made in EU.



Copyright 2022 DD GROUP. All rights reserved.

SPIRAL SERIES

	Model No.	Description	Range	Notes
Pedestals	 SPIRAL 010-017	Adjustable Pedestal	10 - 17 mm	Step height adjustment 1 mm.
	 SPIRAL 017-030	Adjustable Pedestal	17 - 30 mm	Step height adjustment 1 mm.
	 SPIRAL 030-050	Adjustable Pedestal	30 - 50 mm	Step height adjustment 1 mm.
	 SPIRAL 050-070	Adjustable Pedestal	50 - 70 mm	Step height adjustment 1 mm.
	 SPIRAL 070-090	Adjustable Pedestal	70 - 90 mm	Step height adjustment 1 mm.
	 DS60	Height coupler	60 mm	Height coupler allows to extend pedestal height with additional 60 mm (up to 210 mm).
Tabs	 D3 D5	Gap spacer disc	-	Select 3 mm or 5 mm paver gap spacer.
	 L3 L5	Gap spacer	-	Select 3 mm or 5 mm paver gap spacer.
	 AD	Joist adapter	-	For decking joist fixing with pedestals.

Accessories



SH145

Rubber shim SH145

Adds 1,5 mm in height

Noise cancellation and tile thickness compensation.



LE MAX

Self leveling head LE MAX 0-6%

Adds 20 mm in height

Self leveling of the terrace with a slope range from 0% to 6%.



DDPWAP

Up to wall clip

Adds 2,5 mm in height

Use to create a gap between perimeter tile and wall. Prevent tiles displacement and makes a spare space for tiles thermal expansion.



DDP CP

Side finishing closure plate

Adds 3,5 mm in height

It is used to make vertical masking of the ventilated terrace. Two pieces increase the height of the bracket by 7 mm.



SBR 200/3
SBR 200/8

SBR rubber pad

Adds 3 or 8 mm in height

Select 3 mm or 8 mm height option. Placed under the pedestal gives additional protection of the water membrane. Also gives additional noise cancellation.

Copyright 2022 DD GROUP. All rights reserved.

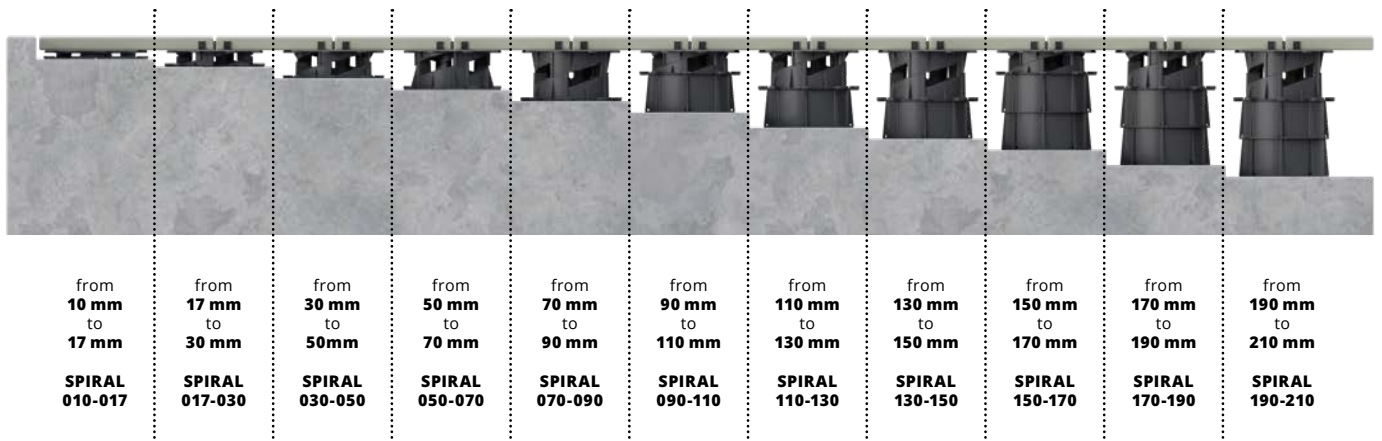

IMPORTANT: Refer to DD PEDESTALS product specifications to ensure proper use and installation. Find specifications at www.ddgro.eu