



## ADJUSTABLE PEDESTALS







### MAX SERIES

- Base slope corrector that eliminates tilt of the pedestals on substrates with a slope (0-6%).
- Load resistance up to 1700 kg on each center loaded pedestal.
- Only 3 pedestals heights to reach basic height adjustment between 45 - 350 mm.
- Reach height 950 mm with 3 height couplers only (it is possible use higher with several conditions).
- Self leveling head automatically adjust to slope.
- Fast installation with unique driller bit tool.
- Manual adjustment for precise height regulation.
- Key from the top to adjust height with paver laid on the pedestals.
- Select 3 mm or 5 mm tab size for pavers.
- Select joist adapter for decking.
- Easily brace high pedestals with metal wire.
- Additional accessories as: Rubber shim, Up to wall perimeter clip, Vertical closure clip, Rubber SBR pads, Windproof system, Driller bit tool, key from the top.
- Made in EU.



Copyright 2022 DD GROUP. All rights reserved.

# MAX SERIES

	<b>Model No.</b>	<b>Description</b>	<b>Range</b>	<b>Notes</b>
Pedestals	 MAX 045-075	Adjustable Pedestal	45 - 75 mm	Smooth height adjustment.
	 MAX 075-150	Adjustable Pedestal	75 - 150 mm	Smooth height adjustment.
	 MAX 150-350	Adjustable Pedestal	150 - 350 mm	Smooth height adjustment.
	 DS200	Height coupler	200 mm	Insert DS200 into MAX 150-350 base or another DS200 to reach up to 950 mm.
Tabs	 D3 D5	Gap spacer disc	-	Select 3 mm or 5 mm paver gap spacer.
	 L3 L5	Gap spacer	-	Select 3 mm or 5 mm paver gap spacer.
	 AD	Joist adapter	-	For decking joist fixing with pedestals.

		SH145	Rubber shim SH145	Adds 1,5 mm in height	Noise cancellation and tile thickness compensation.
		LE MAX	Self leveling head LE MAX 0-6%	Adds 20 mm in height	Self leveling of the terrace with a slope range from 0% to 6%.
		SC	Base slope corrector 0-8%	Adds 30,5 mm in height	Base slope corrector helps to compensate slope of the terrace and makes pedestal stay vertical even if staying on uneven sloped surface.
		DDPWAP	Up to wall clip	Adds 2,5 mm in height	Use to create a gap between perimeter tile and wall. Prevent tiles displacement and makes a spare space for tiles thermal expansion.
Accessories		DDP CP	Side finishing closure plate	Adds 3,5 mm in height	It is used to make vertical masking of the ventilated terrace. Two pieces increase the height of the bracket by 7 mm.
		SBR 220/3	SBR rubber pad	Adds 3 mm in height	Placed under the pedestal gives additional protection of the water membrane. Also gives additional noise cancellation.
		WP	Windproof system	-	System that helps to mechanically fix tiles to the pedestal in case of a high wind exposure. Using that system needs to cut a kerf on the tiles corner edges.
		PPK	Drill driver bit tool	-	Helps with fast height adjustment of the pedestals.
		MPK	Key from the top	-	Helps to make small adjustments after tiles installation. WARNING! Use only with self leveling head.

Copyright 2022 DD GROUP. All rights reserved.



**IMPORTANT:** Refer to DD PEDESTALS product specifications to ensure proper use and installation. Find specifications at [www.ddgro.eu](http://www.ddgro.eu)



## ADJUSTABLE PEDESTALS









### **SPIRAL SERIES**

- Self leveling head automatically adjust to slope (0-6%).
- Load resistance up to 2400 kg on each center loaded pedestal.
- Minimum height starts from 10 mm.
- Step height adjustment, each step is 1 mm.
- Select 3 mm or 5 mm tab size for pavers.
- Select joist adapter for decking.
- Additional accessories as: Rubber shim, Up to wall perimeter clip, Vertical closure clip, Rubber SBR pads.
- Made in EU.

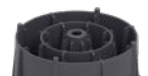

Copyright 2022 DD GROUP. All rights reserved.

# SPIRAL SERIES

	Model No.	Description	Range	Notes
Pedestals	 SPIRAL 010-017	Adjustable Pedestal	10 - 17 mm	Step height adjustment 1 mm.
	 SPIRAL 017-030	Adjustable Pedestal	17 - 30 mm	Step height adjustment 1 mm.
	 SPIRAL 030-050	Adjustable Pedestal	30 - 50 mm	Step height adjustment 1 mm.
	 SPIRAL 050-070	Adjustable Pedestal	50 - 70 mm	Step height adjustment 1 mm.
	 SPIRAL 070-090	Adjustable Pedestal	70 - 90 mm	Step height adjustment 1 mm.
	 DS60	Height coupler	60 mm	Height coupler allows to extend pedestal height with additional 60 mm (up to 210 mm).
Tabs	 D3 D5	Gap spacer disc	-	Select 3 mm or 5 mm paver gap spacer.
	 L3 L5	Gap spacer	-	Select 3 mm or 5 mm paver gap spacer.
	 AD	Joist adapter	-	For decking joist fixing with pedestals.

Accessories



SH145

Rubber shim SH145

Adds 1,5 mm in height

Noise cancellation and tile thickness compensation.



LE MAX

Self leveling head LE MAX 0-6%

Adds 20 mm in height

Self leveling of the terrace with a slope range from 0% to 6%.



DDPWAP

Up to wall clip

Adds 2,5 mm in height

Use to create a gap between perimeter tile and wall. Prevent tiles displacement and makes a spare space for tiles thermal expansion.



DDP CP

Side finishing closure plate

Adds 3,5 mm in height

It is used to make vertical masking of the ventilated terrace. Two pieces increase the height of the bracket by 7 mm.



SBR 200/3  
SBR 200/8

SBR rubber pad

Adds 3 or 8 mm in height

Select 3 mm or 8 mm height option. Placed under the pedestal gives additional protection of the water membrane. Also gives additional noise cancellation.

Copyright 2022 DD GROUP. All rights reserved.

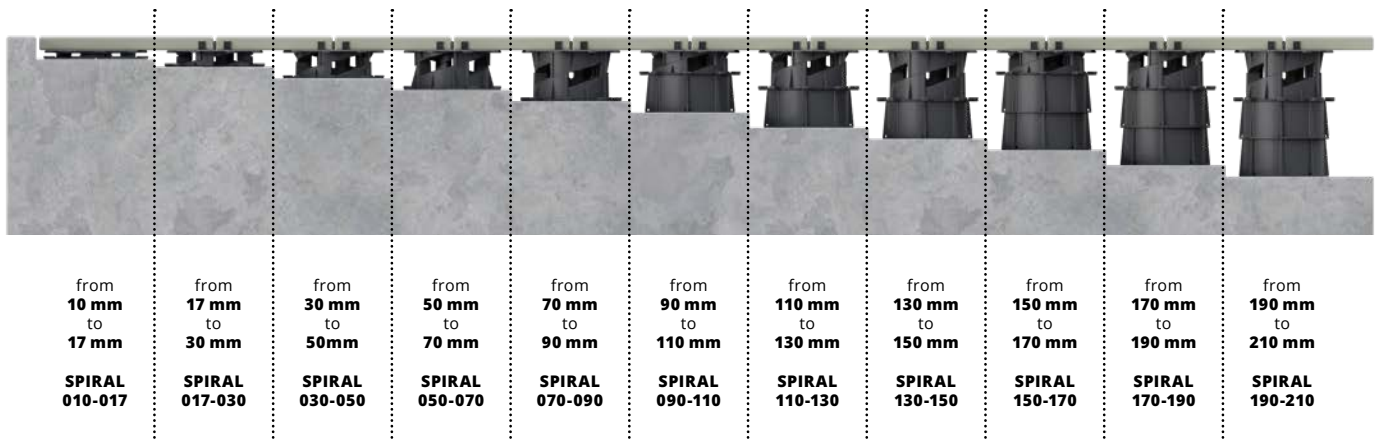

**IMPORTANT:** Refer to DD PEDESTALS product specifications to ensure proper use and installation. Find specifications at [www.ddgro.eu](http://www.ddgro.eu)











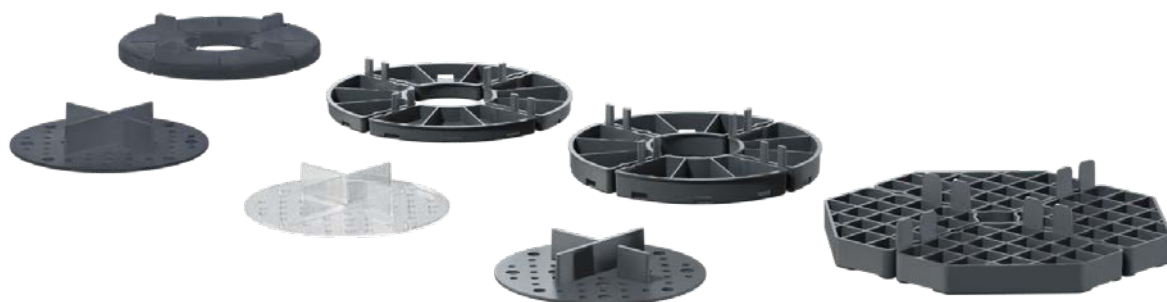





## ADJUSTABLE PEDESTALS

### **SUPPORT PADS SERIES**

- Easy solution for pavers dry installation method.
- Fixed built in 3 mm spacers.
- Different pads models for every type of project.
- Easy to cut to place along the wall.



Copyright 2022 DD GROUP. All rights reserved.

	Model No.	Description	Range	Notes	
Support pads		DDP 002 T DDP 002 B DDP 002 R	Support pad	2 mm	Available in 3 different kind of materials - black standard plastic, soundproof rubber and transparent plastic.
		DDP 008	Support pad	8 mm	Paver spacers are created from an elastic rubber material so they do not need separate rubber shim for noise cancelling. Stackable to 16 or 24 mm.
		DDP 010	Support pad	10 mm	With a stackable design you can raise height of the terrace to 20, 25, 30, 35, 40 and 45 mm.
		DDP 015	Support pad	15 mm	
		DDP 016	Support pad	16 mm	With a stackable design you can raise height of the terrace to 32 and 48 mm.
Accessories		L5	Gap spacer	-	Gap spacers makes 5 mm joint gap between tiles.
		SH100	Rubber shim	Adds 1,5 mm in height	Dedicated to use with fixed height paver spacers DDP 008. Can be used tile thickness compensation.
		SH145	Rubber shim	Adds 1,5 mm in height	Dedicated to use with fixed height paver spacers DDP 010 and DDP 015. Can be used tile thickness compensation.
		SH175	Rubber shim	Adds 1,5 mm in height	Dedicated to use with fixed height paver spacers DDP 016. Can be used tile thickness compensation.
		SBR 100/3 SBR 100/8	SBR rubber pad	Adds 3 or 8 mm in height	Select 3 mm or 8 mm height option. Placed under the pedestal gives additional protection of the water membrane. Also gives additional noise cancellation.
		SBR 200/3 SBR 200/8	SBR rubber pad	Adds 3 or 8 mm in height	

Copyright 2022 DD GROUP. All rights reserved.

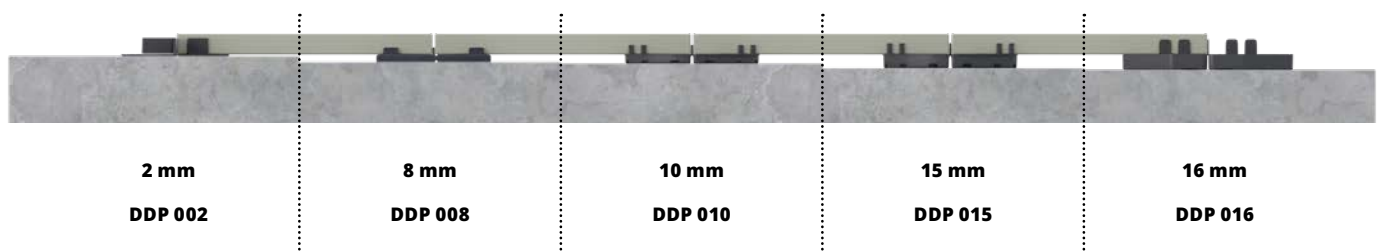

**IMPORTANT:** Refer to DD PEDESTALS product specifications to ensure proper use and installation. Find specifications at [www.ddgro.eu](http://www.ddgro.eu)





## ADJUSTABLE PEDESTALS







### STANDARD SERIES

- Load resistance up to 1100 kg on each center loaded pedestal.
- Only 4 pedestals heights to reach basic height adjustment between 30 - 220 mm.
- Reach height 420 mm with 2 height couplers only.
- Select 3 mm or 5 mm tab size for pavers.
- Select joist adapter for decking.
- Fast installation with unique driller bit tool.
- Manual adjustment for precise height regulation.
- Self leveling head automatically adjust to slope (0-7%).
- Additional accessories as: Rubber shim, Up to wall perimeter clip, Vertical closure clip, Rubber SBR pads, Driller bit tool.
- Made in EU.



Copyright 2022 DD GROUP. All rights reserved.

# STANDARD SERIES

	Model No.	Description	Range	Notes
	 STANDARD 030-045	Adjustable Pedestal	30 - 45 mm	Smooth height adjustment.
	 STANDARD 045-070	Adjustable Pedestal	45 - 70 mm	Smooth height adjustment.
Pedestals	 STANDARD 070-120	Adjustable Pedestal	70 - 120 mm	Smooth height adjustment.
	 STANDARD 120-220	Adjustable Pedestal	120 - 220 mm	Smooth height adjustment.
	 DS100	Height coupler	100 mm	Insert DS100 into STANDARD 120-220 base or another DS100 to reach up to 420 mm.
	 K3 K5	Cross spacer	-	Select 3 mm or 5 mm paver gap spacer.
Tabs	 L3 L5	Gap spacer	-	Select 3 mm or 5 mm paver gap spacer.
	 AD	Joist adapter	-	For decking joist fixing with pedestals.

Accessories		SH100	Rubber shim	Adds 1,5 mm in height	Noise cancellation and tile thickness compensation.
		LE	Self leveling head LE 0-7%	Adds 16 mm in height	Self leveling of the terrace with a slope range from 0% to 7%.
		DDPWAP	Up to wall clip	Adds 2,5 mm in height	Use to create a gap between perimeter tile and wall. Prevent tiles displacement and makes a spare space for tiles thermal expansion.
		DDP CP	Side finishing closure plate	Adds 3,5 mm in height	It is used to make vertical masking of the ventilated terrace. Two pieces increase the height of the bracket by 7 mm.
		PPK	Drill driver bit tool	-	Helps with fast height adjustment of the pedestals.
		SBR 200/3 SBR 200/8	SBR rubber pad	Adds 3 or 8 mm in height	Select 3 mm or 8 mm height option. Placed under the pedestal gives additional protection of the water membrane. Also gives additional noise cancellation.
		SBR 200/3 SBR 200/8	SBR rubber pad	Adds 3 or 8 mm in height	

Copyright 2022 DD GROUP. All rights reserved.



**IMPORTANT:** Refer to DD PEDESTALS product specifications to ensure proper use and installation. Find specifications at [www.ddgro.eu](http://www.ddgro.eu)



## ADJUSTABLE PEDESTALS









### **ALU SERIES**

- Load resistance up to 2000 kg on each center loaded pedestal.
- Height adjustment between 40 - 200 mm.
- Build in self leveling head automatically adjust to slope (0-6%).
- Manual adjustment for precise height regulation.
- Made in EU.



Copyright 2022 DD GROUP. All rights reserved.

# ALU SERIES

	Model No.	Description	Range	Notes	
Pedestals		ALU 040-050	Adjustable Pedestal	40 - 50 mm	Smooth height adjustment. Fire resistance. Self levelling.
		ALU 050-060	Adjustable Pedestal	50 - 60 mm	Smooth height adjustment. Fire resistance. Self levelling.
		ALU 060-075	Adjustable Pedestal	60 - 75 mm	Smooth height adjustment. Fire resistance. Self levelling.
		ALU 070-095	Adjustable Pedestal	70 - 95 mm	Smooth height adjustment. Fire resistance. Self levelling.
		ALU 090-115	Adjustable Pedestal	90 - 115 mm	Smooth height adjustment. Fire resistance. Self levelling.
		ALU 110-135	Adjustable Pedestal	110 - 135 mm	Smooth height adjustment. Fire resistance. Self levelling.
		ALU 130-155	Adjustable Pedestal	130 - 155 mm	Smooth height adjustment. Fire resistance. Self levelling.
		ALU 150-175	Adjustable Pedestal	150 - 175 mm	Smooth height adjustment. Fire resistance. Self levelling.
		ALU 170-200	Adjustable Pedestal	170 - 200 mm	Smooth height adjustment. Fire resistance. Self levelling.

Copyright 2022 DD GROUP. All rights reserved.

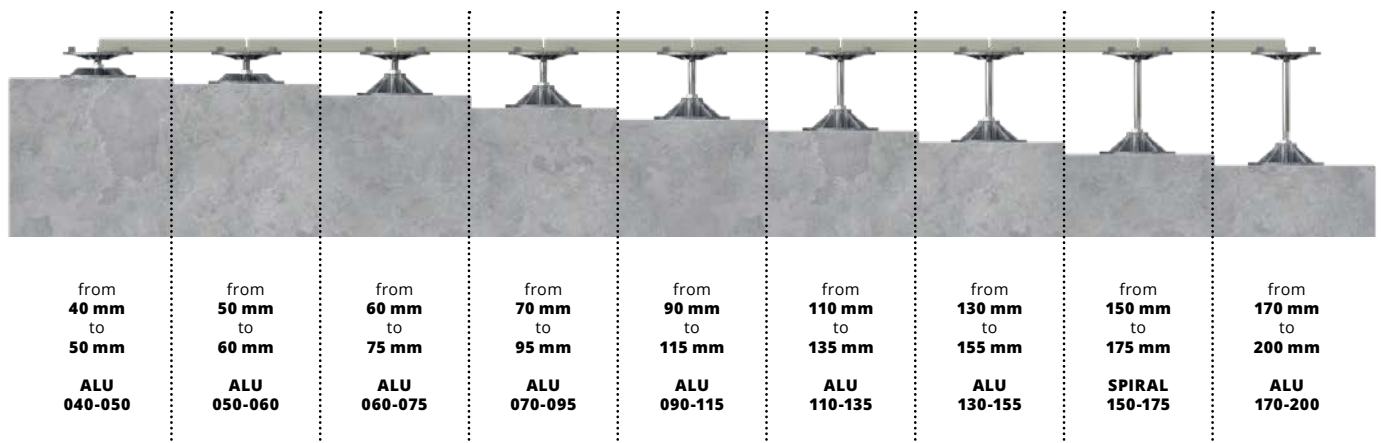

**IMPORTANT:** Refer to DD PEDESTALS product specifications to ensure proper use and installation. Find specifications at [www.ddgro.eu](http://www.ddgro.eu)



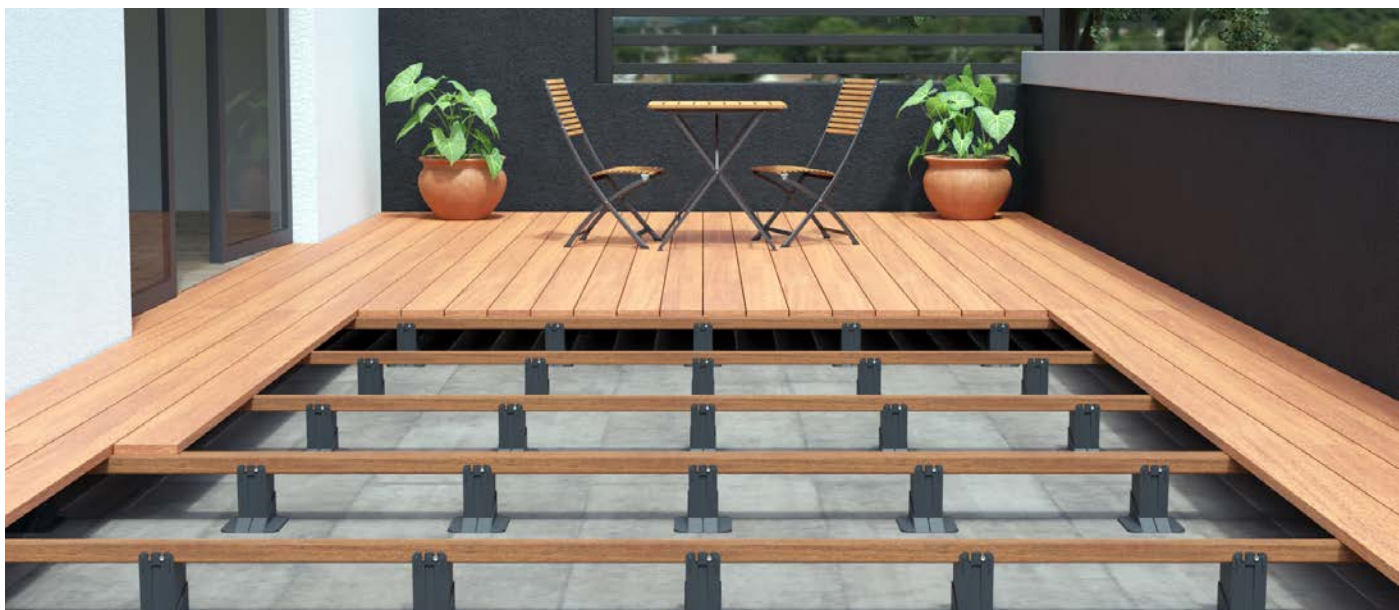

## ADJUSTABLE PEDESTALS

### **RAPTOR SERIES**

- Base slope corrector that eliminates tilt of the pedestals on substrates with a slope (0-7%).
- Load resistance up to 1000 kg on each center loaded pedestal.
- Minimum height starts from 15 mm.
- Height adjustment between 15 - 245 mm.
- Step height adjustment, each step is 1mm.
- Made in EU.



Copyright 2022 DD GROUP. All rights reserved.



# RAPTOR SERIES

	Model No.	Description	Range	Notes
Pedestals	 RAPTOR S 015-035	Adjustable Pedestal	15 - 35 mm	Step height adjustment 1 mm.
	 RAPTOR M 035-065	Adjustable Pedestal	35 - 65 mm	Step height adjustment 1 mm.
	 RAPTOR L 065-095	Adjustable Pedestal	65 - 95 mm	Step height adjustment 1 mm.
	 RAPTOR XL 095-125	Adjustable Pedestal	95 - 125 mm	Step height adjustment 1 mm.
	 P30	Height coupler	30 mm	Insert P30 into RAPTOR XL 095-125 base or another P30 to reach up to 245 mm.
Accessories	 KN	Base slope corrector 0-7%	Adds 10 mm in height	Base slope corrector helps to compensate slope of the terrace and makes pedestal stay vertical even if staying on uneven sloped surface.
	 PO	Paver spacer	Adds 2 mm in height	Gives additional protection for water membrane.
	 PA	Acoustic pad	Adds 10 mm in height	It is placed under the pedestals and gives additional noise protection.
	 SBR 170/3	SBR rubber pad	Adds 3 mm in height	Placed under the pedestal gives additional protection of the water membrane. Also gives additional noise cancellation.

Copyright 2022 DD GROUP. All rights reserved.

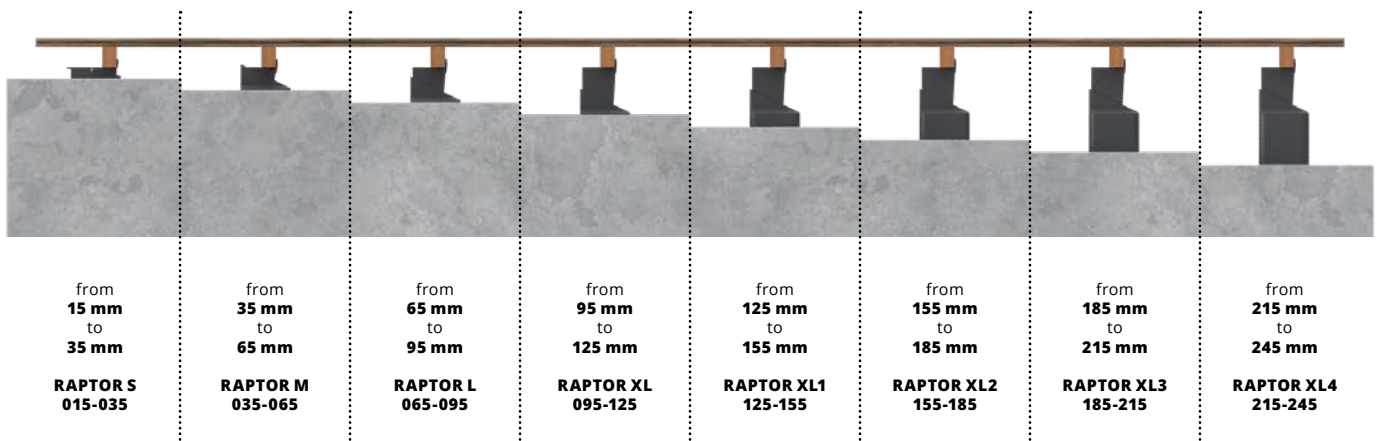

**IMPORTANT:** Refer to RAPTOR product specifications to ensure proper use and installation. Find specifications at [www.ddgro.eu](http://www.ddgro.eu)